

中国标准电源插头

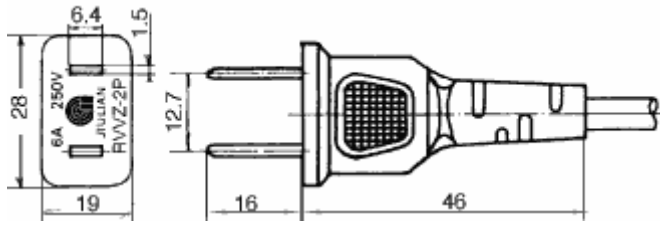

RVVZ-2P

- 227IEC42 (RVB) $2 \times 0.5\text{mm}^2$ 6A250V
- 227IEC42 (RVB) $2 \times 0.75\text{mm}^2$ 6A250V
- 227IEC52 (RVV) $2 \times 0.5\text{mm}^2$ 6A250V
- 227IEC52 (RVV) $2 \times 0.75\text{mm}^2$ 6A250V



RVV-2P

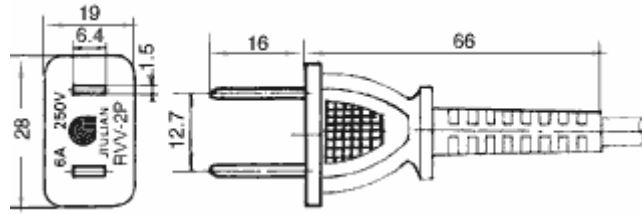

- 227IEC52(RVV) $2 \times 0.75\text{mm}^2$ 6A250V
- 227IEC53(RVV) $2 \times 0.75\text{mm}^2$ 6A250V
- 227IEC53(RVV) $2 \times 1.0\text{mm}^2$ 10A250V



RVVZ-2Y

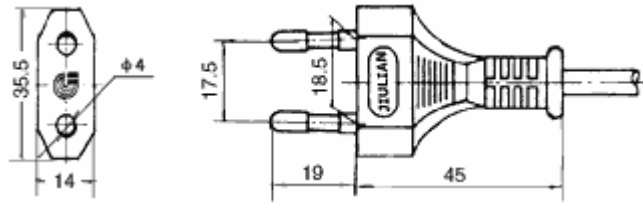

- 227IEC42(RVB) $2 \times 0.5\text{mm}^2$ 6A250V
- 227IEC42(RVB) $2 \times 0.75\text{mm}^2$ 6A250V
- 227IEC52(RVV) $2 \times 0.5\text{mm}^2$ 6A250V
- 227IEC52(RVV) $2 \times 0.75\text{mm}^2$ 6A250V

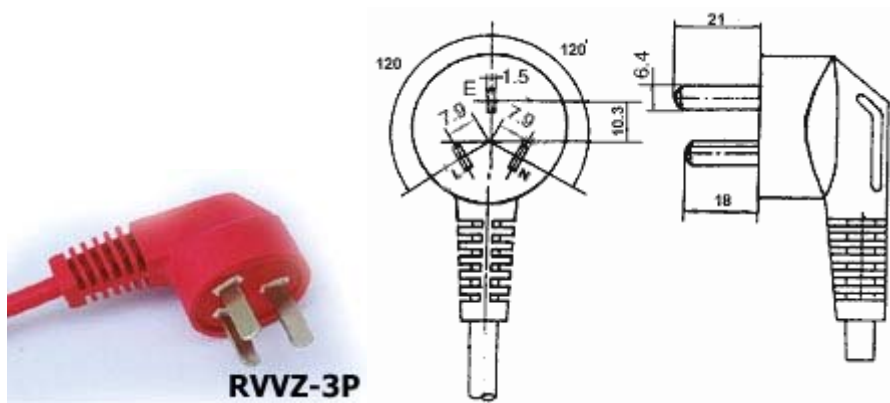

RVVZ-3P

- 227IEC52 (RVV) $3 \times 0.5\text{mm}^2$ 6A250V
- 227IEC52 (RVV) $3 \times 0.75\text{mm}^2$ 6A250V
- 227IEC53 (RVV) $3 \times 0.75\text{mm}^2$ 6A250V
- 227IEC53 (RVV) $3 \times 1.0\text{mm}^2$ 10A250V

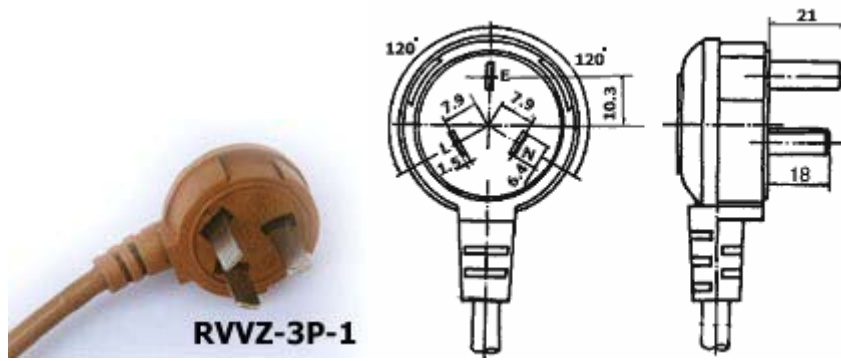

RVVZ-3P-1

- 227IEC52 (RVV) 3×0.5mm² 6A250V
- 227IEC52 (RVV) 3×0.75mm² 6A250V
- 227IEC53 (RVV) 3×0.75mm² 6A250V
- 227IEC53 (RVV) 3×1.0mm² 10A250V

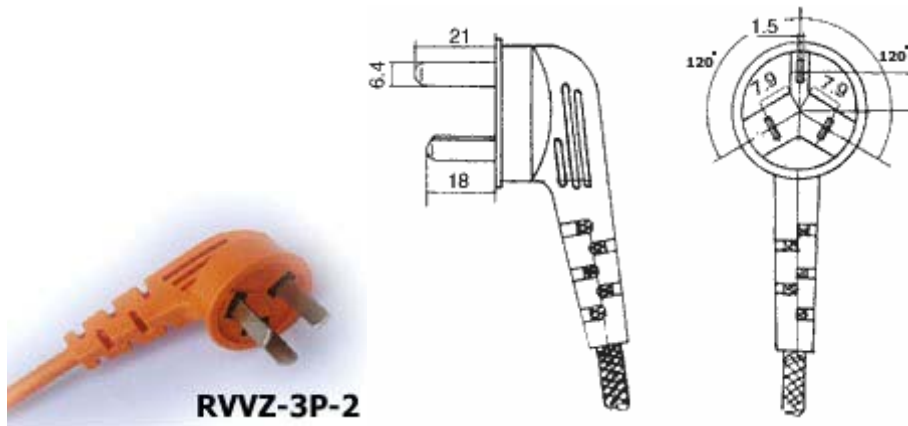

RVVZ-3P-2

- 227IEC52 (RVV) 3×0.5mm² 6A250V
- 227IEC52 (RVV) 3×0.75mm² 6A250V
- 227IEC53 (RVV) 3×0.75mm² 6A250V
- 227IEC53 (RVV) 3×1.0mm² 10A250V
- RX 300/300V 3×0.75mm² 6A250V
- RX 300/300V 3×1.0mm² 10A250V

欧洲标准电源插头

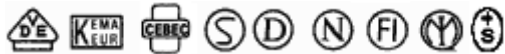

JL201

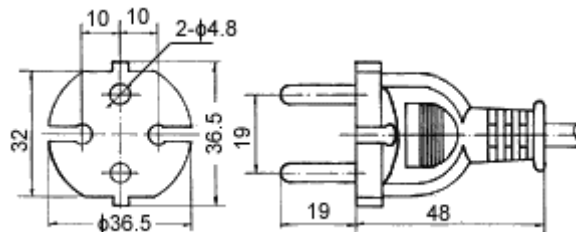

- | | | |
|-----------|-----------------------|------------|
| H03VVH2-F | 2X0.5mm ² | 10/16A250V |
| H03VVH2-F | 2X0.75mm ² | 10/16A250V |
| H03VV-F | 2X0.5mm ² | 10/16A250V |
| H03VV-F | 2X0.75mm ² | 10/16A250V |
| H05VVH2-F | 2X0.75mm ² | 10/16A250V |
| H05VVH2-F | 2X1.0mm ² | 10/16A250V |
| H05VV-F | 2X0.75mm ² | 10/16A250V |
| H05VV-F | 2X1.0mm ² | 10/16A250V |

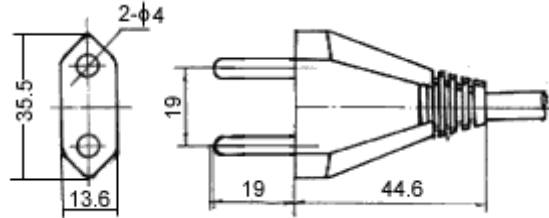

H03VVH2 -F	2X0.5mm ²	2.5A250V
H03VVH2 -F	2X0.75mm ²	2.5A250V
H03VV -F	2X0.5mm ²	2.5A250V
H03VV -F	2X0.75mm ²	2.5A250V
H05VVH2 -F	2X0.75mm ²	10A250V
H05VVH2 -F	2X1.0mm ²	10A250V
H05VV -F	2X0.75mm ²	10A250V
H05VV -F	2X1.0mm ²	10A250V

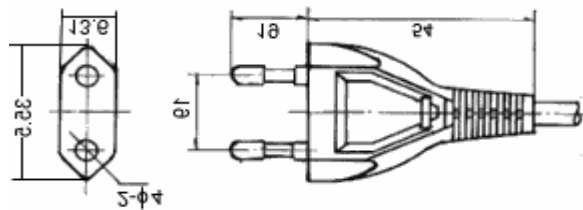

H03VVH2 -F	2X0.5mm ²	2.5A250V
H03VVH2 -F	2X0.75mm ²	2.5A250V
H03VV -F	2X0.5mm ²	2.5A250V
H03VV -F	2X0.75mm ²	2.5A250V
H05VVH2 -F	2X0.75mm ²	10A250V
H05VVH2 -F	2X1.0mm ²	10A250V
H05VV -F	2X0.75mm ²	10A250V
H05VV -F	2X1.0mm ²	10A250V

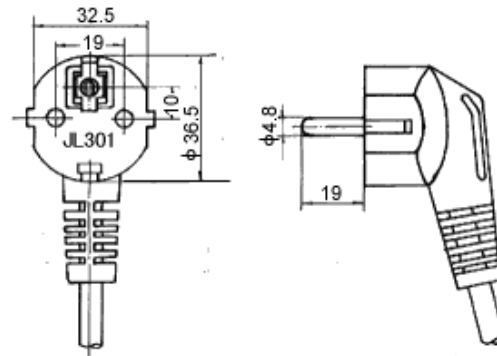

H03VV -F	3G0.5mm ²	10/16A250V
H03VV -F	3G0.75mm ²	10/16A250V
H05VV -F	3G0.75mm ²	10/16A250V
H05VV -F	3G1.0mm ²	10/16A250V
H05VV -F	3G1.5mm ²	10/16A250V

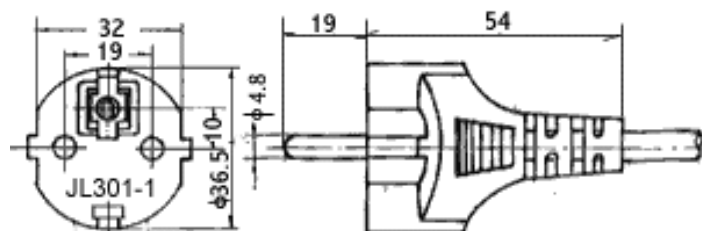

H03VV -F	3G0.5mm ²	10/16A250V
----------	----------------------	------------

H03VV -F
H05VV -F
H05VV -F
H05VV -F

3G0.75mm²
3G0.75mm²
3G1.0mm²
3G1.5mm²

10/16A250V
10/16A250V
10/16A250V
10/16A250V



JL301A

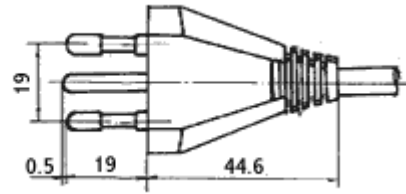
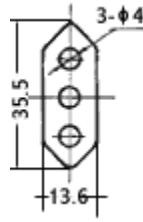

H03VV -F
H03VV -F
H05VV -F
H05VV -F

3G0.5mm²
3G0.75mm²
3G0.75mm²
3G1.0mm²

10A250V
10A250V
10A250V
10A250V



JL301B

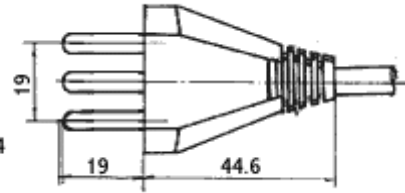
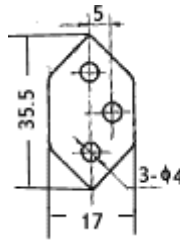

H03VV -F
H03VV -F
H05VV -F
H05VV -F

3G0.5mm²
3G0.75mm²
3G0.75mm²
3G1.0mm²

10A250V
10A250V
10A250V
10A250V



JL301F

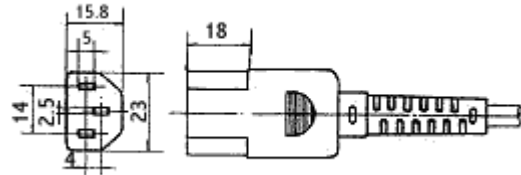

227IEC52(RVV)
227IEC53(RVV)
227IEC53(RVV)
H03VV -F
H05VV -F
H05VV -F

3X0.75mm²
3X0.75mm²
3X1.0mm²
3G0.75mm²
3G0.75mm²
3G1.0mm²

10A250V
10A250V
10A250V
6A250V
10A250V
10A250V



JL301M

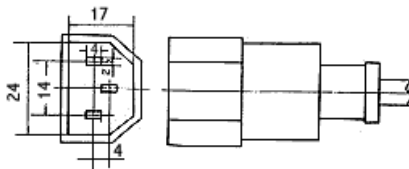

227IEC52(RVV)
227IEC53(RVV)
227IEC53(RVV)
H03VV -F
H05VV -F
H05VV -F

3X0.75mm²
3X0.75mm²
3X1.0mm²
3G0.75mm²
3G0.75mm²
3G1.0mm²

10A250V
10A250V
10A250V
6A250V
10A250V
10A250V

澳大利亚标准电源插头

SAA



JL004S-1

H05VVH2-F

H05VV-F

H05VV-F

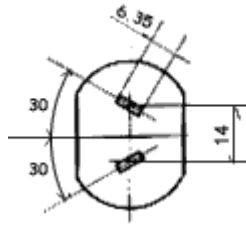

2X0.75mm²

2X0.75mm²

2X1.0mm²

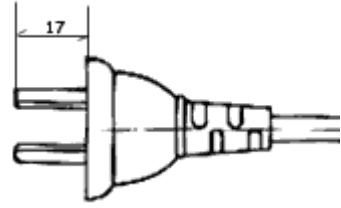

7.5A250V

7.5A250V

10A250V



JL004S

H05VVH2-F

H05VV-F

H05VV-F



2X0.75mm²

2X0.75mm²

2X1.0mm²

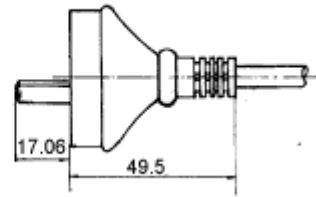

7.5A250V

7.5A250V

10A250V



JL004S3

H05VV-F

H05VV-F

H05VV-F

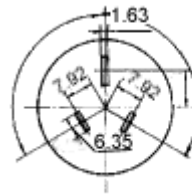

3G0.75mm²

3G1.0mm²

3G1.5mm²

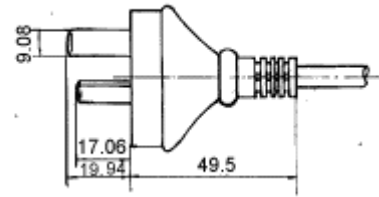

7.5A250V

10A250V

15A250V

美国标准电源插头



JL001

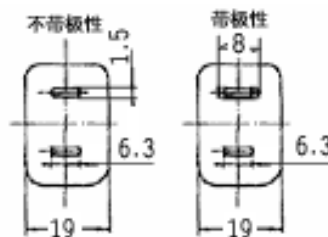

18AWG/2C

18AWG/2C

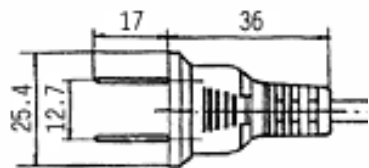

SPT-1

SPT-2

SPT-2	16AWG/2C
SPT-3	18AWG/2C
SPT-3	16AWG/2C
SVT	18AWG/2C
SVT	17AWG/2C
NISPT-1	18AWG/2C
NISPT-2	18AWG/2C

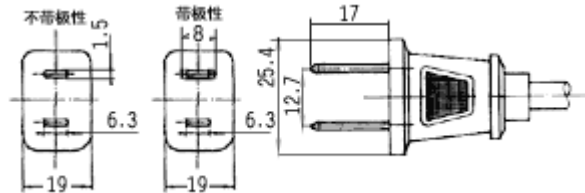

SVT	18AWG/2C
SVT	17AWG/2C
ST	18AWG/2C
ST	16AWG/2C
SJT	18AWG/2C
SJT	16AWG/2C
NISPT-1	18AWG/2C
NISPT-2	18AWG/2C

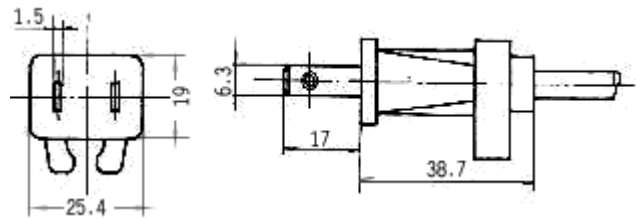

SVT	18AWG/2C
SVT	17AWG/2C
SVT	18AWG/2C(齿形)
SVT	17AWG/2C(齿形)
ST	18AWG/2C
ST	16AWG/2C

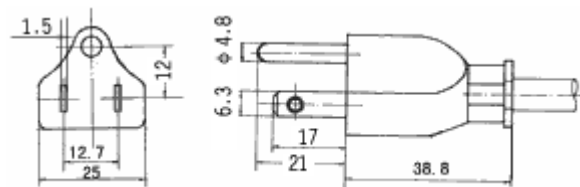

SPT-1	18AWG/3C
SPT-2	18AWG-16AWG/3C
SPT-3	18AWG-16AWG/3C
SVT	18AWG-17AWG/3C
SVT	18AWG-17AWG/3C(齿形)
ST	18AWG-16AWG/3C
SJT	18AWG-16AWG/3C

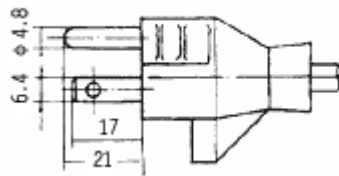
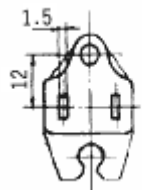

SVT	18AWG/3C
SVT	17AWG/3C
SVT	18AWG/3C(齿形)
SVT	17AWG/3C(齿形)
ST	18AWG/3C
ST	16AWG/3C
SJT	16AWG/3C
SJT	18AWG/3C

日本标准电源插头

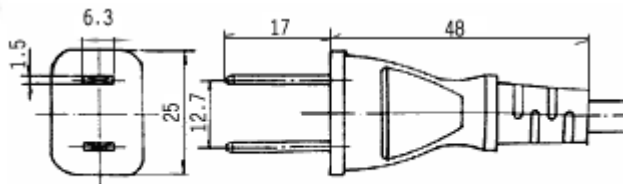

VFF	2X0.75mm ²	7A125V
VCTF	2X0.75mm ²	7A125V
VCTFK	2X0.75mm ²	7A125V



JL001-B

以色列 南非 英国电源插头



以色列电源插头

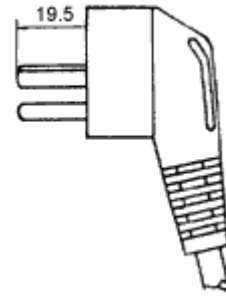
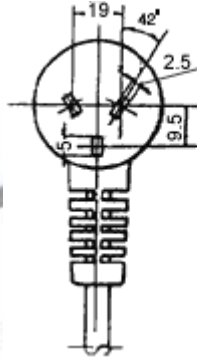

H03VV-F	3G0.75mm ²
H05VV-F	3G0.75mm ²
H05VV-F	3G1.0mm ²
H05VV-F	3G1.5mm ²



南非电源插头

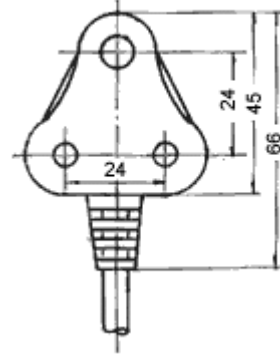
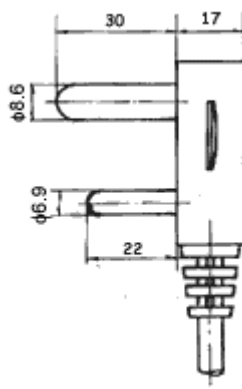

H03VV-F	3G0.75mm ²
H05VV-F	3G0.75mm ²
H05VV-F	3G1.0mm ²
H05VV-F	3G1.5mm ²



英国电源插头

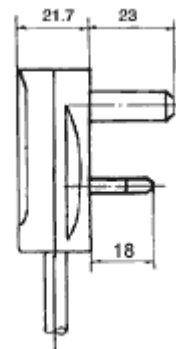
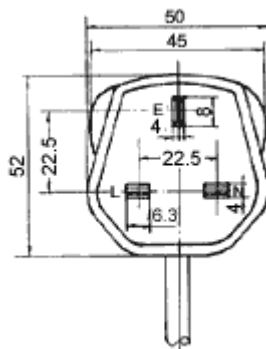

H03VV-F	3G0.5mm ²
H03VV-F	3G0.75mm ²
H05VV-F	3G0.75mm ²
H05VV-F	3G1.0mm ²
H05VV-F	3G1.5mm ²

认证国家名称代号

认证国家	简称	认证标志	认证机构
中国	CCC		国家认证认可监督管理委员会
欧洲	CENELEC		欧洲电气标准委员会
欧洲	CEE		欧洲电气机器统一安全规格委员会
德国	VDE		德国电气技术者协会
荷兰	KEMA		荷兰电气标准
德国	TUV		德国莱茵技术监督协会
瑞士	SEV		瑞士电器标准
瑞典	SEMKO		瑞典电器标准
挪威	NEMKO		挪威电气机器试验所
丹麦	DEMKO		丹麦电气机器试验所
芬兰	SFS		芬兰电气机械标准
奥地利	OVE		奥地利电气机械标准
比利时	NBN		比利时电气用品标准
意大利	IMQ		意大利家电机噐试验所
法国	NF		法国国家标准
澳洲	SAA		澳洲国家标准协会
美国	UL		美国保险协会实验室
加拿大	CSA		加拿大标准协会
日本	T-MARK		日本电器标准
英国	BS		英国规格协会

欧洲标准电源线



- 标准: DIN VDE0281
- 型号: H03VVH2-F H03VV-F
H05VVH2-F H05VV-F
- 额定电压: H03 300/300V
H05 300/500V
- 应用: H03 型适用小功率家用电器、电动工具及动力照明等。
H05 型适用大功率家用电器电动工具及照明等
- 构造

H03VVH2-F & H05VVH2-F

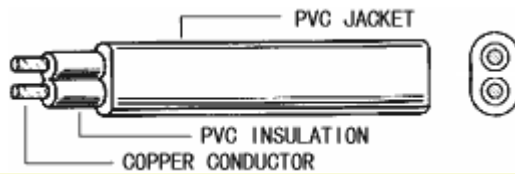

H03VV-F & H05VV-F

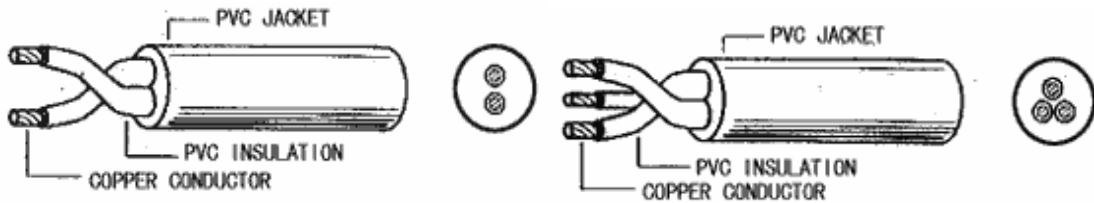

H03VVH2-F & H03VV-F

芯数	面积(mm ²)	结构(No/mm)	绝缘厚度(mm)	护套厚度(mm)	完成外径(mm)
2	0.5	28/0.15	0.5	0.5	3.3X5.4
2	0.5	28/0.15			5.4
2	0.75	42/0.15			3.4X5.6
2	0.75	42/0.15			5.6
3	0.5	28/0.15			5.6
3	0.75	42/0.15			6.1

H05VVH2-F & H05VV-F

芯数	面积(mm ²)	结构(No/mm)	绝缘厚度(mm)	护套厚度(mm)	完成外径(mm)
2	0.75	42/0.15	0.6	0.8	6.5
2	0.75	42/0.15			4.1X6.5
2	1.0	32/0.2			6.7
2	1.0	32/0.2			4.3X6.9
2	1.5	48/0.2	0.8	7.7	
3	0.75	42/0.15	0.6	0.9	6.8
3	1.0	32/0.2			7.3
3	1.5	48/0.15			8.4



导线

- 标准: GB5023.3-1997
- 型号: 227 IEC 02(RV), 227 IEC 08(RV-90)
- 额定电压: 227 IEC 02(RV) 450/750V
227 IEC 08(RV-90) 300/500V
- 应用: 02 型适用各种家用电器、仪器仪表连接等
08 型适用各种家用电器高温下连接
- 构造

227 IEC 02(RV) & 227 IEC 08(RV-90)

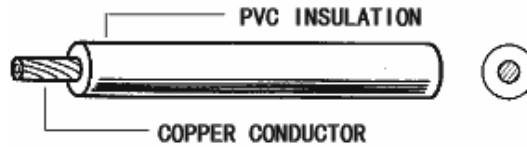

227 IEC 02(RV)

导体		绝缘	
面积(mm ²)	构造(No./mm)	标称厚度(mm)	完成外径(mm)
1.5	48/0.2	0.7	3.0
2.5	80/0.2	0.8	3.65

227 IEC 08(RV-90)

导体		绝缘	
面积(mm ²)	构造(No./mm)	标称厚度(mm)	完成外径(mm)
0.75	42/0.15	0.6	2.6
1.0	32/0.2	0.6	2.8
1.5	48/0.2	0.7	3.05
2.5	80/0.2	0.8	3.7

扁型软线

- 标准: GB5023.5-1997
- 型号: 227 IE C42(RVB)
- 额定电压: 300/300V
- 应用: 适用于小功率家用电器及照明。
- 构造

227 IEC 42(RVB)

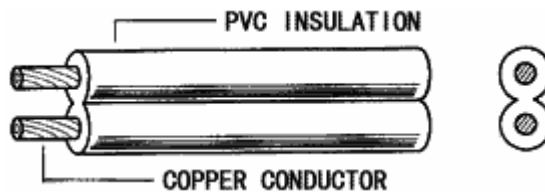

227 IEC 42(RVB)

导体			绝缘厚度(mm)	完成外径(mm)
芯数	面积(mm ²)	结构(No./mm)		
2	0.5	28/0.15	0.8	2.7×5.4

2	0.75	42/0.15	0.8	2.9×5.8
---	------	---------	-----	---------

护套软电线

- 标准: GB5023.5-1997
- 型号: 227 IEC 52(RVV), 227 IEC 53(RVV)
- 额定电压: 227 IEC 52(RVV) 300/300V
227 IEC 53(RVV) 300/500V
- 应用: 227 IEC 52(RVV) 适用于小功率家用电器、电动工具以及动力照明等。
227 IEC 53(RVV) 适用于大功率家用电器、电动工具以及动力照明等。
- 构造

227 IEC 52(RVV) & 227 IEC 53(RVV)

扁型

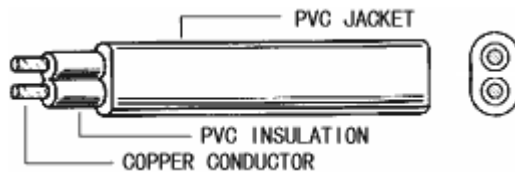

圆型芯数

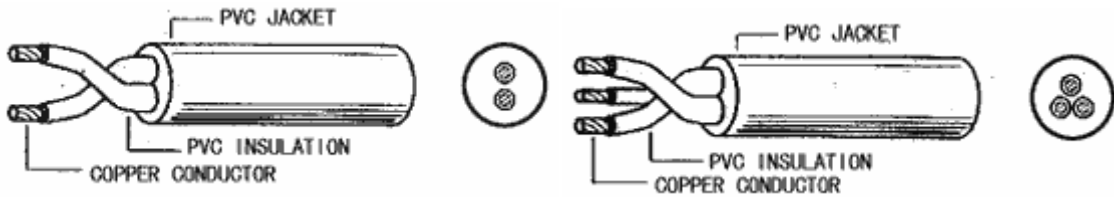

227 IEC 52(RVV)

芯数	面积(mm ²)	结构(No/mm)	绝缘厚度(mm)	护套厚度(mm)	完成外径(mm)
2	0.5	28/0.15	0.5	0.6	5.3
2	0.5	28/0.15			3.26×5.3
2	0.75	42/0.15			5.7
2	0.75	42/0.15			3.4×5.8
3	0.5	28/0.15			5.6
3	0.75	42/0.15			6.05

227 IEC 53(RVV)

芯数	面积(mm ²)	结构(No/mm)	绝缘厚度(mm)	护套厚度(mm)	完成外径(mm)
2	0.75	42/0.15	0.6	0.8	6.5
2	0.75	42/0.15	0.6		4.1×6.5
2	1.0	32/0.2	0.6		6.9
2	1.5	48/0.2	0.7		7.7
3	0.75	42/0.15	0.6		6.9
3	1.0	32/0.2	0.6		7.4
3	1.5	48/0.2	0.7	0.9	8.5

日本标准电源线



VFF

- 标准: JIS C 3306
- 型号: VFF
- 额定电压: 300V
- 使用温度: 75°C
- 应用: 适用于各种家用电器、电动工具及动力照明。

· 构造

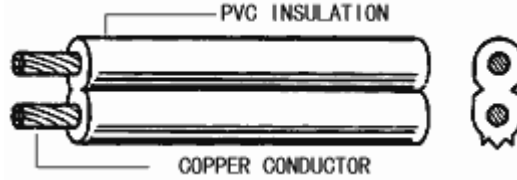

芯数	面积(mm ²)	结构(No/mm)	绝缘厚度(mm)	完成外径(mm)
2	0.5	20/0.18	0.8	2.5×5.0
2	0.75	30/0.18		2.7×5.4
2	1.25	50/0.18		3.1×6.2

VCTFK & VCTF

- 标准: JIS C 3306
- 型号: VCTFK&VCTF
- 额定电压: 300V
- 使用温度: 75°C
- 应用: 适用于各种家用电器、电动工具及动力照明。
- 构造

VCTFK

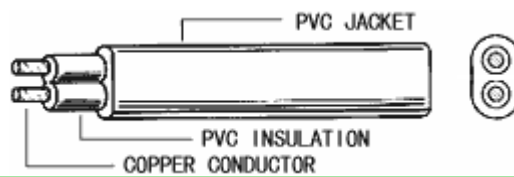

VCTF

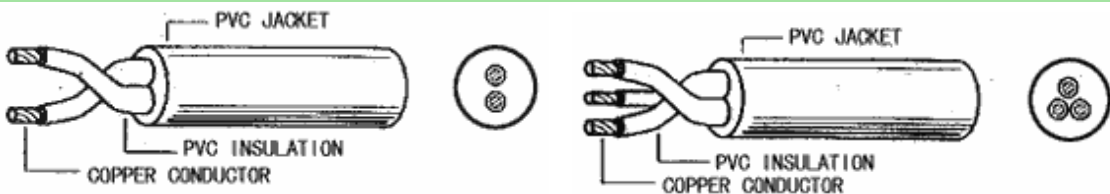

VCTFK & VCTF

型号	芯数	面积(mm ²)	结构(No/mm)	绝缘厚度(mm)	护套厚度(mm)	完成外径(mm)
VCTFK	2	0.75	30/0.18	0.6	1.0	4.2×6.5
	2	1.25	50/0.18			4.7×7.4
VCTF	2	0.75	30/0.18	0.6	1.0	6.6
	2	1.25	50/0.18			7.4

	3	0.75	30/0.18			7.0
	3	1.25	50/0.18			8.5

美国标准电源线



- 标准: UL62
- 型号: SPT-1, SPT-2, SPT-3, NISPT-2, SVT, ST, SJT
- 额定电压: 300V, 600V (ST)
- 使用温度: 60°C/105°C
- 应用: 适用于各种家用电器、电动工具及动力照明。
- 构造

SPT-1 & SPT-2 & SPT-3



型号	芯数	线规	面积(mm ²)	结构(No/mm)	护套厚度(mm)	完成外径(mm)
SPT-1	2	18	0.823	41/0.16	0.76	2.7X5.4
	3	18	0.823	41/0.16	0.76	2.7X7.5
SPT-2	2	18	0.823	41/0.16	1.14	3.5X6.9
	2	16	1.31	2.6/0.253		3.7X7.5
	3	18	0.823	41/0.16		3.6X8.6
	3	16	1.31	26/0.253		3.9X9.6
SPT-3	2	18	0.823	41/0.16	1.52	4.4X7.8
	2	16	1.31	26/0.253		4.5X9.1
	3	18	0.823	41/0.16		4.3X9.8
	3	16	1.31	26/0.253		4.6X11.8

NISPT-1 & NISPT-2

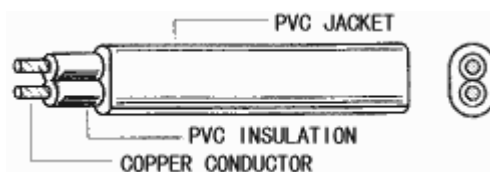

型号	芯数	线规	面积(mm ²)	结构(No/mm)	绝缘厚度(mm)	护套厚度(mm)	完成外径(mm)
NISPT-1	2	18	0.823	41/0.16	0.38	0.38	3.1x6.0
NISPT-2	2	18	0.823	41/0.16	0.76	0.38	4.0x7.6

SVT & ST & SJT

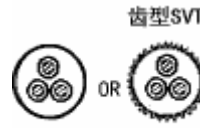
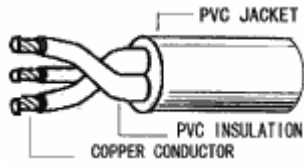
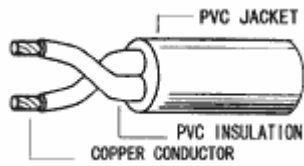

型号	芯数	线规	面积(mm ²)	结构(No/mm)	绝缘厚度(mm)	护套厚度(mm)	完成外径(mm)
SVT	2	18	0.823	41/0.16	0.38	0.76	5.9±0.1
	3	18	0.823	41/0.16			6.3±0.1
	2	17	1.04	52/0.16			6.4±0.1
	3	17	1.04	52/0.16			6.8±0.1
ST	2	18	0.823	41/0.16	0.76	1.52	8.5±0.15
	3	18	0.823	41/0.16			8.9±0.15
	2	16	1.31	26/0.253			9.3±0.15
	3	16	1.31	26/0.253			9.8±0.15
SJT	2	18	0.823	41/0.16	0.76	0.76	7.4±0.15
	2	16	1.31	26/0.253			7.8±0.15
	2	14	2.08	41/0.253			8.6±0.15
	3	18	0.823	41/0.16			7.8±0.15
	3	16	1.31	26/0.253			8.4±0.15
	3	14	2.08	41/0.253			9.3±0.15

澳洲标准电源线

SAA

- 标准: SAA AS 3191-1994
- 型号: H03VVH2-F H03VV-F
H05VVH2-F H05VV-F
- 额定电压: H03 300/300V
H05 300/500V
- 应用: H03 型适用小功率家用电器、电动工具及动力照明等。
H05 型适用大功率家用电器电动工具及照明等
- 构造

H03VVH2-F & H05VVH2-F

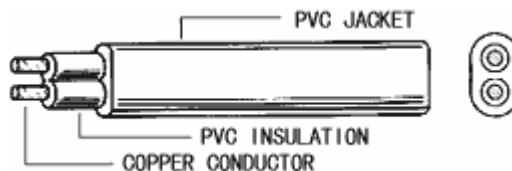

H03VV-F & H05VV-F

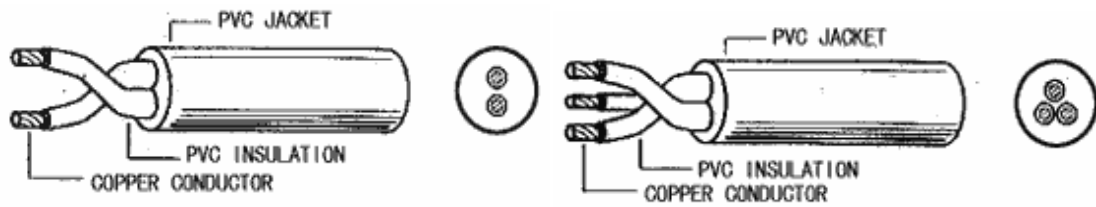

H03VVH2-F & H03VV-F

芯数	面积(Sqmm)	结构(No/mm)	绝缘厚度(mm)	护套厚度(mm)	完成外径(mm)
2	0.5	28/0.15	0.5	0.5	3.3X5.4
2	0.5	28/0.15			5.4
2	0.75	42/0.15			3.7X5.8
2	0.75	42/0.15			5.6
3	0.5	28/0.15			5.6
3	0.75	42/0.15			6.1

H05VVH2-F & H05VV-F

芯数	面积(Sqmm)	结构(No/mm)	绝缘厚度(mm)	护套厚度(mm)	完成外径(mm)
2	0.75	42/0.15	0.6	0.8	6.5
2	0.75	42/0.15			4.1X6.5
2	1.0	32/0.2			6.9
2	1.5	48/0.2	0.8		7.7
3	0.75	42/0.15	0.6	0.8	6.8
3	1.0	32/0.2			7.3
3	1.5	48/0.15	0.8	0.9	8.4